

1 適用範圍:

- 1.1 本承認書適用於無鉛、無鹵符合RoHS條款的金屬板微電阻器。
- 1.2 該產品是屬於通用型系列。
- 1.3 AEC-Q200的報告可依據客戶要求提供。

2 型別名稱:

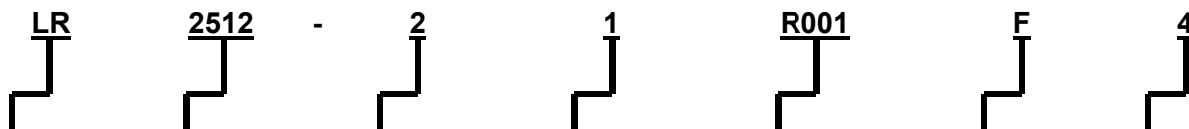

型別	尺寸	端子數	額定功率	電阻值	容差	包裝數量
金屬板微電阻	<ul style="list-style-type: none"> • 1206 • 2010 • 2512 • 2725 • 2728 • 4527 • 4527S 	2 : 2 個端電極	<ul style="list-style-type: none"> • C=0.5W • 1=1.0W • A=1.5W • 2=2.0W • 3=3.0W • B=3.5W • 4=4.0W • 5=5.0W 	EX: R001 = 1mΩ R010 = 10mΩ R100 = 100mΩ R00025 = 0.25mΩ	D=± 0.5% F=± 1.0% G=± 2.0% J=± 5.0%	A=500pcs 1=1,000pcs 2=2,000pcs 4=4,000pcs

IE		QA	Sales	備註	發行管制章 DATA Center.
制訂	審查	核准	會簽	會簽	
					非發行管制文件 自行注意版本更新 非經允許，禁止自行影印文件
					Series No. 60

3 規格表：

型別	端電極數	最高 額定功率	最高 額定電流	最高 過負荷 電流	溫度係數 T.C.R. (ppm/°C)	阻值範圍 (mΩ)		使用溫度範圍
						D (±0.5%)	F (±1%); G (±2%); J (±5%)	
LR1206	2	0.5W	40.82A	81.64A	0.3mΩ: ≤±450 0.5~0.9mΩ: ≤±175 1.0~15.0mΩ: ≤±75 15.1~50.0mΩ: ≤±50	7.0~50.0	0.3~50.0	-55~170°C
		1W	57.74A	115.47A	0.3mΩ: ≤±450 0.5~0.9mΩ: ≤±175 1.0~15.0mΩ: ≤±75 15.1~50.0mΩ: ≤±50	7.0~50.0	0.3~50.0	
		1.5W	70.71A	141.42A	0.3mΩ: ≤±450 0.5~0.9mΩ: ≤±175 1.0mΩ: ≤±75	--	0.3~1.0	
LR2010	1W	44.72A	89.44A	0.5~0.9 mΩ: ≤±100 1.0~1.9mΩ: ≤±75 2.0~6.9mΩ: ≤±50 7.0~100mΩ: ≤±25	7.0~49	0.5~100		
	1.5w	54.77A	109.54A	0.5~0.9 mΩ: ≤±100 1.0~1.9mΩ: ≤±75 2.0~6.9mΩ: ≤±50 7.0~40mΩ: ≤±25	7.0~40	0.5~40		
	2W	63.25A	126.49	0.5~0.9 mΩ: ≤±100 1.0~1.9mΩ: ≤±75 2.0~6.9mΩ: ≤±50 7.0~12mΩ: ≤±25	7.0~12	0.5~12		
LR2512	1W	57.74A	129.10A	0.3mΩ: ≤±150 0.5~1.0mΩ: ≤±75 1.1~3.0mΩ: ≤±50 3.1~100mΩ: ≤±25	7.0~50	0.3~100		
	1.5W	70.71A	158.11A	0.3mΩ: ≤±150 0.5~1.0mΩ: ≤±75 1.1~3.0mΩ: ≤±50 3.1~75mΩ: ≤±25	7.0~50	0.3~75.0		
	2W	81.65A	182.57A	0.3mΩ: ≤±150 0.5~1.0mΩ: ≤±75 1.1~2.5mΩ: ≤±50 2.6~10.0mΩ: ≤±25	7.0~10.0	0.3~10.0		
	3W	100.00A	223.61A	0.20mΩ: ≤±100 0.25~3.0mΩ: ≤±50	--	0.20~3.0		
LR2725	4W	126.49A	252.95A	0.20 mΩ: ≤±100 0.25~0.5mΩ: ≤±50	--	0.20~0.5		
	5W	158.11A	273.86A	4.0~100mΩ: ≤±25	4.0~19.0	4.0~100		
LR2728	3W	27.39A	47.43A	4.0~100mΩ: ≤±25	4.0~19.0	4.0~100		
	3.5W	29.58A	51.23A	4.0~50.0mΩ: ≤±25	4.0~19.0	4.0~50.0		
	4W	31.62A	63.25A					

備

非發行管制文件
自行注意版本更新

發行管制章 DATA Center.

註

非經允許，禁止自行影印文件

Series No. 60

型別	端電極數	最高 額定功率	最高 額定電流	最高 過負荷 電流	溫度係數 T.C.R. (ppm/°C)	阻值範圍 (mΩ)		使用溫度範圍
						D (±0.5%)	F (±1%); G (±2%); J (±5%)	
LR4527S (without heat sink)	2	2W	63.25A	109.54	0.5~1.0m: ≤±75 1.1~100mΩ: ≤±50	7.0~100	0.5~100	-55~170°C
		3W	77.5A	134A	0.5~1.0mΩ: ≤±75 1.1~27mΩ: ≤±50	7.0~27	0.5~27	
		5W	100A	173A	0.5~1.0mΩ: ≤±75 1.1~7.5mΩ: ≤±50	7.0~7.5	0.5~7.5	
LR4527	5W	100A	173A	0.5~1.0mΩ: ≤±75 1.1~200mΩ: ≤±50	7.0~120	0.5~200		

3.1 功率衰減曲線：

使用溫度範圍： - 55 ~+170 °C

當電阻工作在溫度超過 70°C 時，額定功率必須減額,減額曲線依據下圖：

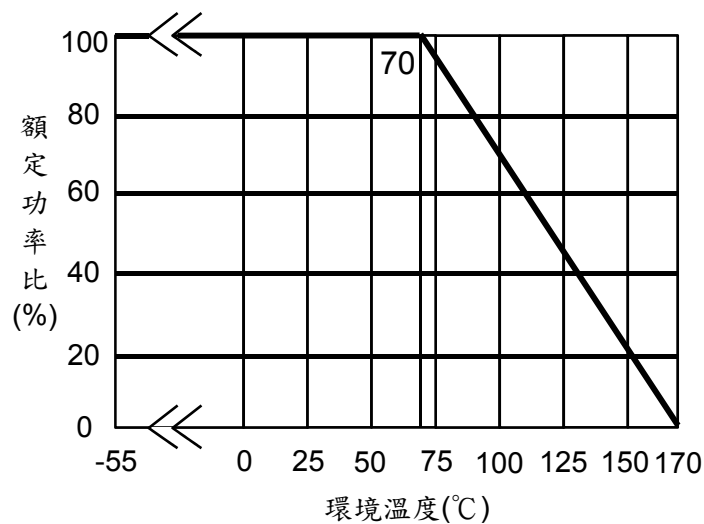

3.2 額定電流：

額定電流:對於額定功率之直流或交流(商用週率有效值rms)電壓。

可用下列公式求得，但求得之值若超過規格表內之最高電壓時，則以最高額定電壓為其額定電壓。

$$I = \sqrt{P/R}$$

I =額定電流(A)

P=:額定功率(W)

R=Resistance(Ω)

備

非發行管制文件
自行注意版本更新

發行管制章 DATA Center.

註

非經允許，禁止自行影印文件

Series No. 60

4 尺寸及構造

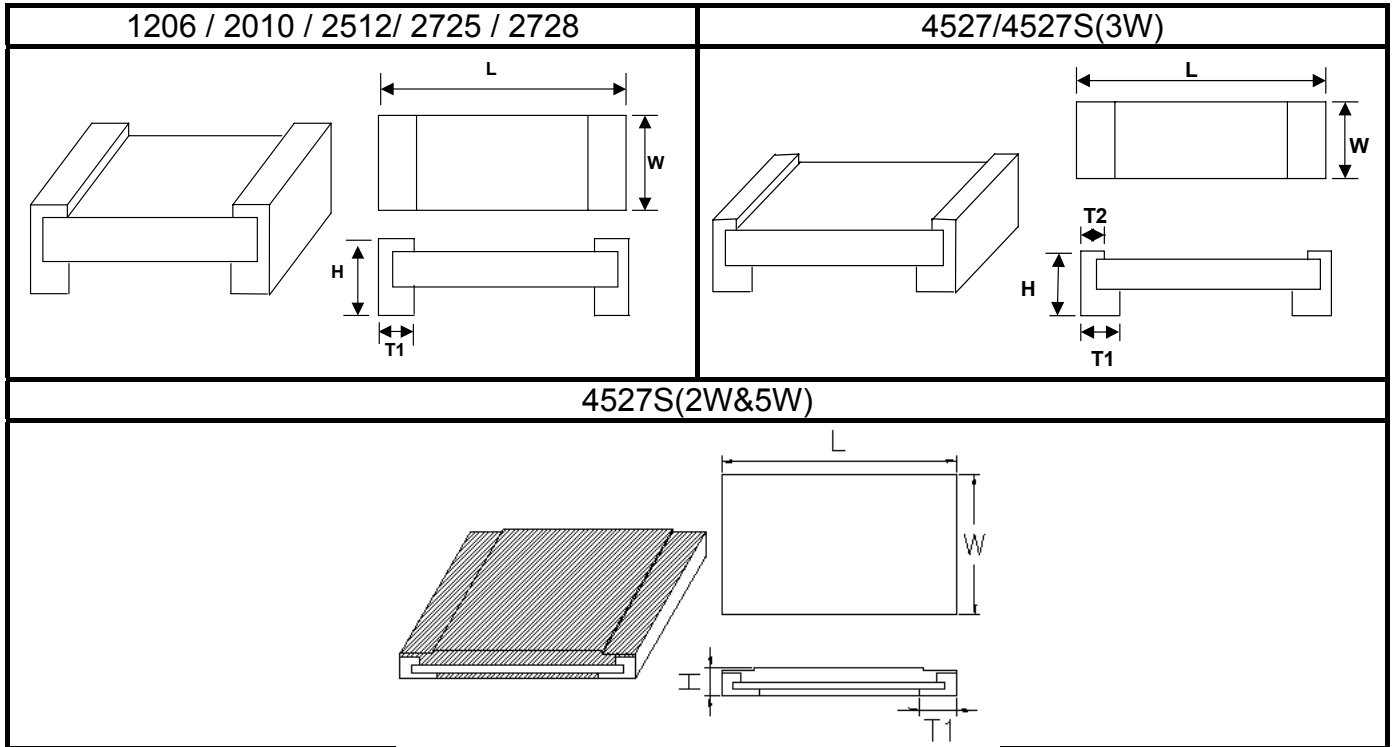

型別	最高 額定功率	阻值範圍 (mΩ)	尺寸 - 英吋(mm)					
			L	W	H	T1	T2	
LR1206	0.5 & 1.0	0.3	0.126±0.010 (3.200±0.254)	0.063±0.010 (1.600±0.254)	0.039±0.010 (1.000±0.254)	0.022±0.010 (0.550±0.254)	X	
		0.5~0.6				0.029±0.010 (0.725±0.254)		
		1.0				0.025±0.010 (0.645±0.254)		
		2.0 ~ 4.0				0.020±0.010 (0.508±0.254)		
		5.0				0.024±0.010 (0.600±0.254)		
		6.0 ~50.0				0.020±0.010 (0.508±0.254)		
	1.5	0.3				0.039±0.010 (1.000±0.254)		0.022±0.010 (0.550±0.254)
		0.5~0.6				0.029±0.010 (0.725±0.254)		0.020±0.010 (0.508±0.254)
		1.0				0.025±0.010 (0.645±0.254)		0.020±0.010 (0.508±0.254)
LR2010	1.0 & 1.5 & 2.0	0.5 ~ 0.9	0.200±0.010 (5.080±0.254)	0.100±0.010 (2.540±0.254)	0.031±0.010 (0.787±0.254)	0.057±0.010 (1.440±0.254)		
		1.0 ~ 3.0				0.051±0.010 (1.295±0.254)		
		3.1 ~ 4.0				0.031±0.010 (0.787±0.254)		
		4.1 ~100.0						

備註

非發行管制文件
自行注意版本更新

非經允許，禁止自行影印文件

發行管制章 DATA Center.

Series No. 60

型別	最高 額定功率	阻值範圍 (mΩ)	尺寸 - 英寸(mm)				
			L	W	H	T1	T2
LR2512	1.0 & 1.5	0.3	0.246±0.010 (6.248±0.254)	0.126±0.010 (3.202±0.254)	0.040±0.010 (1.000±0.254)	0.079±0.010 (2.02±0.254)	
		0.5 ~ 3.0			0.031±0.010 (0.787±0.254)	0.074±0.010 (1.880±0.254)	
		3.1 ~ 4.0			0.025±0.010 (0.645±0.254)	0.044±0.010 (1.118±0.254)	
		4.1 ~ 75.0			0.025±0.010 (0.645±0.254)	0.034±0.010 (0.868±0.254)	
		75.1 ~ 100.0			0.040±0.010 (1.000±0.254)	0.079±0.010 (2.02±0.254)	
	2.0	0.3			0.031±0.010 (0.787±0.254)	0.074±0.010 (1.880±0.254)	
		0.5 ~ 3.0			0.031±0.010 (0.787±0.254)	0.074±0.010 (1.880±0.254)	
					0.031±0.010 (0.787±0.254)	0.074±0.010 (1.880±0.254)	
LR2512	2.0	3.1 ~ 4.0	0.246±0.010 (6.248±0.254)	0.126±0.010 (3.202±0.254)	0.031±0.010 (0.787±0.254)	0.074±0.010 (1.880±0.254)	
		4.1 ~ 75.0			0.0254±0.010 (0.645±0.254)	0.044±0.010 (1.118±0.254)	
	3.0	0.3			0.040±0.010 (1.000±0.254)	0.079±0.010 (2.02±0.254)	
		0.5			0.074±0.010 (1.880±0.254)	0.074±0.010 (1.880±0.254)	
		0.6 ~ 2.9			0.031±0.010 (0.787±0.254)	0.044±0.010 (1.118±0.254)	
		3.0 ~ 4.0			0.066±0.010 (1.676±0.254)	0.066±0.010 (1.676±0.254)	
		4.1 ~ 10.0			0.025±0.010 (0.645±0.254)	0.044±0.010 (1.118±0.254)	
					0.025±0.010 (0.645±0.254)	0.044±0.010 (1.118±0.254)	
LR2725	4.0 & 5.0	0.20 ~ 0.50	0.268±0.010 (6.807±0.254)	0.254±0.010 (6.452±0.254)	0.039±0.010 (0.991±0.254)	0.085±0.010 (2.159±0.254)	
		0.60			0.071±0.010 (1.803±0.254)	0.071±0.010 (1.803±0.254)	
		1.0			0.043±0.010 (1.092±0.254)	0.085±0.010 (2.159±0.254)	
		1.5			0.039±0.010 (0.991±0.254)	0.071±0.010 (1.803±0.254)	
		2.0			0.035±0.010 (0.889±0.254)	0.065±0.010 (1.651±0.254)	
		2.25~2.5			0.051±0.010 (1.295±0.254)	0.051±0.010 (1.295±0.254)	
		3.0			0.035±0.010 (0.889±0.254)	0.065±0.010 (1.651±0.254)	
LR2728	3.0 & 3.5 & 4.0	4.0~100.0	0.264±0.010 (6.706±0.254)	0.283±0.010 (7.188±0.254)	0.039±0.010 (0.991±0.254)	0.045±0.010 (1.143±0.254)	
LR4527S (without heat sink)	2.0	0.5	0.450±0.010 (11.430±0.254)	0.270±0.010 (6.850±0.254)	0.055±0.010 (1.400±0.254)	0.127±0.010 (3.215±0.254)	
		0.6 ~ 3.0					
		4.0 ~ 5.0					
		5.1 ~ 100					
	3.0	0.5	0.450±0.010 (11.430±0.254)	0.270±0.010 (6.850±0.254)	0.055±0.010 (1.400±0.254)	0.127±0.010 (3.215±0.254)	0.038±0.010 (0.965±0.254)
0.6 ~ 3.0							

備

非發行管制文件
自行注意版本更新

發行管制章 DATA Center.

註

非經允許，禁止自行影印文件

Series No. 60

型別	最高 額定功率	阻值範圍 (mΩ)	尺寸 - 英寸(mm)				
			L	W	H	T1	T2
LR4527S (without heat sink)	3.0	4.0 ~ 5.0	0.450±0.010 (11.430±0.254)	0.270±0.010 (6.850±0.254)	0.055±0.010 (1.400±0.254)	0.127±0.010 (3.215±0.254)	0.038±0.010 (0.965±0.254)
		5.1 ~ 27				0.071±0.010 (1.815±0.254)	
	5.0	0.5	0.450±0.010 (11.430±0.254)	0.270±0.010 (6.850±0.254)	0.055±0.010 (1.400±0.254)	0.127±0.010 (3.215±0.254)	X
		0.6 ~ 3.0					
		4.0 ~ 5.0					
		5.1 ~ 7.5					
LR4527	5.0	0.5	0.450±0.010 (11.430±0.254)	0.270±0.010 (6.850±0.254)	0.059±0.010 (1.500±0.254)	0.127±0.010 (3.215±0.254)	0.038±0.010 (0.965±0.254)
		0.6 ~ 3.0					
		4.0 ~ 5.0					
		5.1 ~ 200					

4.1 合金板材料：

型別	Watts	材料	阻值
1206	0.5	錳銅合金	≤ 4.0mΩ
	1.0	鐵鉻鋁合金	> 4.0mΩ
	1.5		
2010	1.0	錳銅合金	≤ 4.0mΩ
	1.5	鐵鉻鋁合金	> 4.0mΩ
	2.0		
2512	1.0	錳銅合金	< 3.5mΩ
	1.5	鐵鉻鋁合金	≥ 3.5mΩ
	2.0		
	3.0	錳銅合金	≤ 2.5mΩ
		鐵鉻鋁合金	≥ 3.0mΩ
2725	4.0	錳銅合金	≤ 0.5mΩ
	5.0	鐵鉻鋁合金	> 0.5mΩ
2728	3.0	鐵鉻鋁合金	All
	3.5		
	4.0		
4527	2.0	錳銅合金	≤ 3.0mΩ
	3.0	鐵鉻鋁合金	≥ 4.0mΩ
	5.0		

備

非發行管制文件
自行注意版本更新

發行管制章 DATA Center.

註

非經允許，禁止自行影印文件

Series No. **60**

5 信賴性試驗項目:

5.1 電氣性能試驗(Electrical Performance Test)

Test Item 項目	Conditions of Test 條件	Test Limits 規格																																			
Temperature Coefficient of Resistance 溫度係數	$\text{TCR (ppm/}^\circ\text{C)} = \frac{(R2-R1)}{R1 (T2-T1)} \times 10^6$ <ul style="list-style-type: none"> 室溫下量測之阻值(Ω) R2: 150 $^\circ\text{C}$ 下量測之阻值(Ω) T1: 室溫之溫度($^\circ\text{C}$) T2: 150 $^\circ\text{C}$ 依據 JIS C 5201-1 4.8 	參考 3.規格表																																			
Short Time Overload 短時間過負荷	施加過負荷5秒，靜置30分鐘以上再量測阻值變化率。 (過負荷條件下表)	$\leq \pm 0.5\%$ $\leq \pm 2.0\%$ (4527 & 4527S series) 外觀無損傷，無短路或燒毀現象																																			
	<table border="1"> <thead> <tr> <th>型別</th> <th>額定功率</th> <th>額定功率倍數</th> </tr> </thead> <tbody> <tr> <td rowspan="3">LR1206</td> <td>0.5</td> <td rowspan="6">4 倍</td> </tr> <tr> <td>1.0</td> </tr> <tr> <td>1.5</td> </tr> <tr> <td rowspan="3">LR2010</td> <td>1.0</td> </tr> <tr> <td>1.5</td> </tr> <tr> <td>2.0</td> </tr> <tr> <td rowspan="4">LR2512</td> <td>1.0</td> <td rowspan="4">5 倍</td> </tr> <tr> <td>1.5</td> </tr> <tr> <td>2.0</td> </tr> <tr> <td>3.0</td> </tr> <tr> <td rowspan="2">LR2725</td> <td>4.0</td> <td>4 倍</td> </tr> <tr> <td>5.0</td> <td>3 倍</td> </tr> <tr> <td rowspan="3">LR2728</td> <td>3.0</td> <td rowspan="6">3 倍</td> </tr> <tr> <td>3.5</td> </tr> <tr> <td>4.0</td> </tr> <tr> <td rowspan="3">LR4527S</td> <td>2.0</td> </tr> <tr> <td>3.0</td> </tr> <tr> <td>5.0</td> </tr> <tr> <td>LR4527</td> <td>5.0</td> <td></td> </tr> </tbody> </table>	型別	額定功率	額定功率倍數	LR1206	0.5	4 倍	1.0	1.5	LR2010	1.0	1.5	2.0	LR2512	1.0	5 倍	1.5	2.0	3.0	LR2725	4.0	4 倍	5.0	3 倍	LR2728	3.0	3 倍	3.5	4.0	LR4527S	2.0	3.0	5.0	LR4527	5.0		
	型別	額定功率	額定功率倍數																																		
	LR1206	0.5	4 倍																																		
		1.0																																			
		1.5																																			
	LR2010	1.0																																			
		1.5																																			
		2.0																																			
	LR2512	1.0	5 倍																																		
1.5																																					
2.0																																					
3.0																																					
LR2725	4.0	4 倍																																			
	5.0	3 倍																																			
LR2728	3.0	3 倍																																			
	3.5																																				
	4.0																																				
LR4527S	2.0																																				
	3.0																																				
	5.0																																				
LR4527	5.0																																				
	Refer to JIS C 5201-1 4.13																																				
Insulation Resistance 絕緣電阻試驗	將金屬板微電阻置於治具上，在正負極施加 100VDC 一分鐘後，測量電極與保護層及電極與基板(底材)間之絕緣電阻值 依據 JIS-C5201-1 4.6	$\geq 10^9 \Omega$																																			
Dielectric Withstanding Voltage 絕緣耐電壓	將金屬板微電阻置於治具上，在正、負極施加 500VAC。 限制突波電流：50mA(max.) 依據 JIS-C5201-1 4.7	無短路或燒毀現象。																																			

備

非發行管制文件
自行注意版本更新

發行管制章 DATA Center.

註

非經允許，禁止自行影印文件

Series No. 60

5.2 機械性能試驗(Mechanical /Constructional Performance Test)

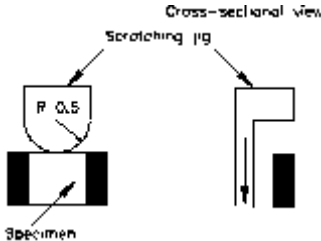
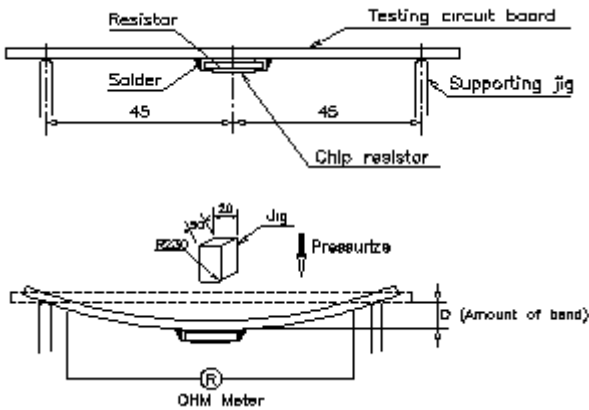
Test Item 項目	Conditions of Test 條件	Test Limits 規格
Resistance to Solder Heat 抗焊錫熱	將金屬板微電阻浸漬於 $260\pm 5^{\circ}\text{C}$ 之錫爐中 10 ± 1 秒，取出靜置60分鐘以上，再量測阻值變化率。 依據 JIS-C5201-1 4.18	$\leq \pm 0.5\%$ 外觀無損傷
Solderability 焊錫性	將金屬板微電阻浸漬於 $245\pm 5^{\circ}\text{C}$ 之爐中 3 ± 1 秒後取出置於顯微鏡下觀察焊錫面積。	導體吃錫面積應大於 95%。
Core Body Strength 本體強度	使用R0.5的測試探針在本體中央向下施加5N的負載持續10 sec。 依據 JIS-C5201-1 4.15	$\leq \pm 0.5\%$ 外觀無損傷
Joint Strength of Solder 焊錫粘合強度	<p>前處理: 將晶片電阻放置於PCT試驗機內，在溫度105°C、濕度100%及氣壓1.22×10^5 pa的飽和條件下進行4小時的老化測試，取出後靜置於室溫下2小時。</p> <p>◎試驗項目一(固著性測試): 將晶片電阻焊於固著性測試板中，置於端電極測試機上，以半徑R0.5之測試探針朝施力方向施加力量，並保持10 sec，於負荷下量測阻值變化率。 力量：17.7N</p>  <p>依據JIS-C5201-1 4.32</p>	<p>試驗項目一: (1)$\leq \pm 0.5\%$ (2)外觀無損傷、無側導脫落。</p> <p>試驗項目二: (1)$\leq \pm 0.5\%$ (2).外觀無損傷、無側導脫落及本體斷裂發生。</p>
	<p>◎試驗項目二(彎折性測試): 將晶片電阻焊於彎折性測試板中，置於彎折測試機上，在測試板中央施力下壓，於負荷下量測阻值變化率。 下壓深度(D)：2mm</p>  <p>依據JIS-C5201-1 4.33</p>	

備註

非發行管制文件
自行注意版本更新

非經允許，禁止自行影印文件

發行管制章 DATA Center.

Series No. 60

Test Item 項目	Conditions of Test 條件	Test Limits 規格
Resistance to solvent 耐溶劑性試驗	將金屬板微電阻浸漬於20~25°C異丙醇溶劑中60±5秒後，取出靜置48小時以上，再量測阻值變化率。 依據 JIS-C5201-1 4.29	≤±0.5% 外觀無損傷
Vibration 耐振性試驗	震動頻率:10 Hz ~ 55 Hz ~ 10 Hz/分 振幅:1.5 mm 測試時間:12小時 (X.Y.Z 3個方向各4小時) 依據 JIS-C5201-1 4.22	≤±0.5% 外觀無損傷

5.3 環境試驗 Environmental Performance:

Test Item 項目	Conditions of Test 條件	Test Limits 規格						
Low Temperature Exposure (Storage) 低溫放置	將金屬板微電阻放置-55±2°C恆溫箱中1000小時，取出後靜置60分鐘以上後再量測阻值變化率。 依據 JIS-C5201-1 4.23.4	≤±0.5% 外觀無損傷						
High Temperature Exposure (Storage) 高溫放置	將金屬板微電阻置於170±5°C之烤箱中1000小時，取出靜置1小時以上再量測阻值變化率。 依據 JIS-C5201-1 4.23.2	≤±1.0% 外觀無損傷						
Temperature Cycling (Rapid Temperature Change) 溫度循環	將金屬板微電阻置入冷熱循環機中，溫度為-55°C/15分鐘，+150°C/15分鐘，共計循環 1000 次後取出，靜置 60 分鐘。以上再量測阻值變化率。 <table border="1" style="margin-left: 20px;"> <tr> <td></td> <td>測試條件</td> </tr> <tr> <td>最低溫度</td> <td>-55 +0/-10°C</td> </tr> <tr> <td>最高溫度</td> <td>150 +10/-0°C</td> </tr> </table> 依據 JIS-C5201-1 4.19		測試條件	最低溫度	-55 +0/-10°C	最高溫度	150 +10/-0°C	≤±0.5% 外觀無損傷
	測試條件							
最低溫度	-55 +0/-10°C							
最高溫度	150 +10/-0°C							
Moisture Resistance (Climatic Sequence) 耐濕試驗	將金屬板微電阻置於恆溫恆濕循環機中，並依步驟1至步驟7(參考圖一) 施加10個濕熱循環，取出靜置24小時以上再量測阻值變化率。 依據 MIL-STD 202 Method 106	≤±0.5% 外觀無損傷						
Bias Humidity 高溫高濕	將金屬板微電阻置於85°C±5°C/ 85 ±5%RH之恆濕恆溫循環機中施加額定電流，90分鐘ON，30分鐘OFF，共1,000小時取出靜置60分鐘以上再量測阻值變化率。 依據 JIS-C5201-1 4.24	≤±0.5% 外觀無損傷						

備

非發行管制文件
自行注意版本更新

發行管制章 DATA Center.

註

非經允許，禁止自行影印文件

Series No. 60

Test Item 項目	Conditions of Test 條件	Test Limits 規格										
Whisker 試驗	<p>◎測試項目(冷熱衝擊測試): 將晶片電阻置放於冷熱衝擊試驗箱內, 並依下列條件做測試, 試驗後置於室溫下2小時。</p> <table border="1"> <thead> <tr> <th colspan="2">測試條件</th> </tr> </thead> <tbody> <tr> <td>最低儲存溫度</td> <td>-55+0/-10°C</td> </tr> <tr> <td>最高儲存溫度</td> <td>85+10/0°C</td> </tr> <tr> <td>溫度保留時間</td> <td>10分</td> </tr> <tr> <td>溫度循環次數</td> <td>1,500</td> </tr> </tbody> </table> <p>◎檢查:將放大鏡的倍數調至40或大於40的倍數下做視察和測試, 如果此方法難做出判斷, 我們可以改用掃描電子顯微鏡(SEM), 且將倍數調至1000或大於1000倍數下做視察和測試。 依據JESD- Standard NO.22A121 class2.</p>	測試條件		最低儲存溫度	-55+0/-10°C	最高儲存溫度	85+10/0°C	溫度保留時間	10分	溫度循環次數	1,500	Whisker長度在50µm之內。
測試條件												
最低儲存溫度	-55+0/-10°C											
最高儲存溫度	85+10/0°C											
溫度保留時間	10分											
溫度循環次數	1,500											

5.4 負荷壽命試驗(Operational Life Endurance:)

Test Item 項目	Conditions of Test 條件	Test Limits 規格
Load Life 負荷壽命	將金屬板微電阻置於70±2°C之烤箱中施加額定電流, 90分鐘ON, 30分鐘OFF, 共1,000小時取出靜置60分鐘以上再量測阻值變化率。 依據 JIS-C5201-1 4.25	<p>≤±1.0%</p> <p>≤±2.0% (4527 & 4527S series)</p> <p>外觀無損傷</p>

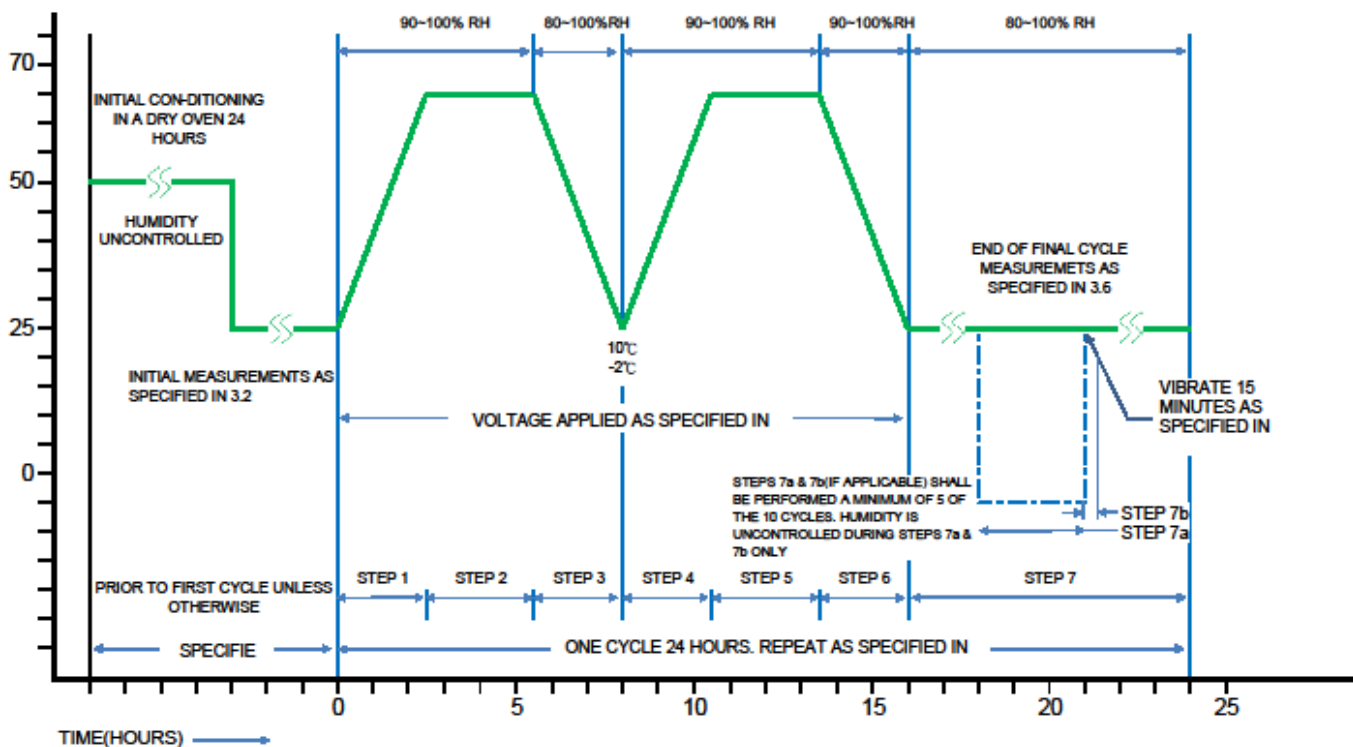

備註

非發行管制文件
自行注意版本更新

非經允許, 禁止自行影印文件

發行管制章 DATA Center.

Series No. 60

6 字碼表示法: (所有產品均以4字碼表示)

6.1 產品阻值是以兩種方式表示：

- a. 以“R”字指示 Ω 的小數點位置
 - 例如 1m Ω 產品字碼是 R001
 - 例如 25m Ω 產品字碼是 R025
 - 例如 100m Ω 產品字碼是 R100
- b. 以“m”字指示 m Ω 的小數點位置
 - 例如 0.25m Ω 產品字碼是 0m25
 - 例如 0.5m Ω 產品字碼是 0m50
 - 例如 5.5m Ω 產品字碼是 5m50
 - 例如 25.5m Ω 產品字碼是 25m5

6.2 LR1206：

6.2.1 1.0m Ω 以上及0.3 m Ω :

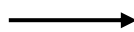
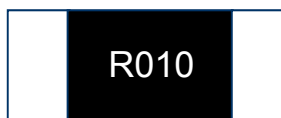

Ex. Resistance 10m Ω (for all LR1206 products)

6.2.2 0.5~0.6 m Ω :(方塊記號)

確定正背面。

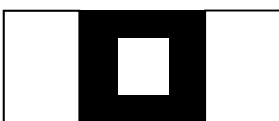

6.3 LR2010：

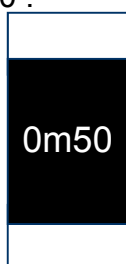

Ex. Resistance 0.5m Ω (when resistance below than 1m Ω)

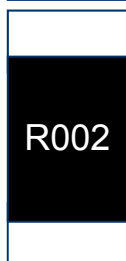

Ex. Resistance 2m Ω (when resistance below or equal than 3m Ω)

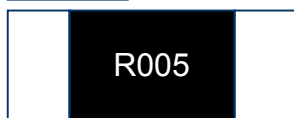

Ex. Resistance 5m Ω (when resistance greater than 3m Ω)

備

非發行管制文件
自行注意版本更新

發行管制章 DATA Center.

註

非經允許，禁止自行影印文件

Series No. 60

6.4 LR2512 :

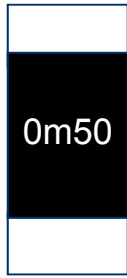

Ex. Resistance 0.5mΩ (when resistance below than 1mΩ)



Ex. Resistance 3mΩ (when resistance below or equal than 4mΩ)



Ex. Resistance 5mΩ (when resistance greater than 4mΩ)

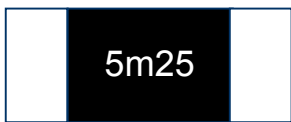

Ex. Resistance 5.25mΩ (when resistance greater than 4mΩ)

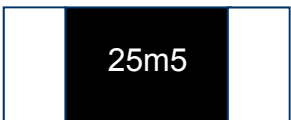

Ex. Resistance 25.5mΩ (when resistance greater than 4mΩ)

6.5 LR2725 :

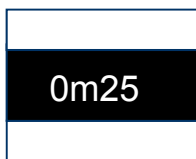

Ex. Resistance 0.25mΩ (or 0.25mΩ only)



Ex. Resistance 2.5mΩ (for 1.5mΩ and 2.5mΩ only)



Ex. Resistance 3mΩ (for 1m、2m and 3mΩ only)

6.6 LR2728 :



Ex. Resistance 5mΩ (for all LR2728 products)

6.7 LR4527 :

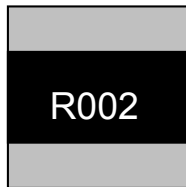

Ex: Resistance 2mΩ.

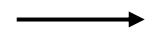
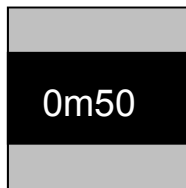

Ex: Resistance 0.5mΩ.

6.8 LR4527S(3W) :

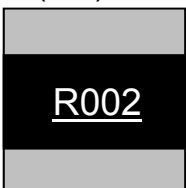

Ex: Resistance 2mΩ.

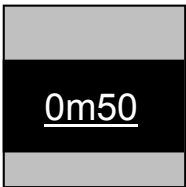

Ex: Resistance 0.5mΩ.

6.9 LR4527S(2W&5W) :

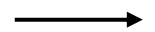

Ex: Resistance 2mΩ.



Ex: Resistance 0.5mΩ.

備

非發行管制文件
自行注意版本更新

發行管制章 DATA Center.

註

非經允許，禁止自行影印文件

Series No. 60

6.10 標準字碼外觀一覽表:

Type \ Marking	R	m	1	2	3	4	5	6	7	8	9	0
LR1206 LR2010 LR2512 LR2725 LR2728 LR4527 LR4527S	R	m	1	2	3	4	5	6	7	8	9	0

7 包裝規格:

7.1 承載帶尺寸:

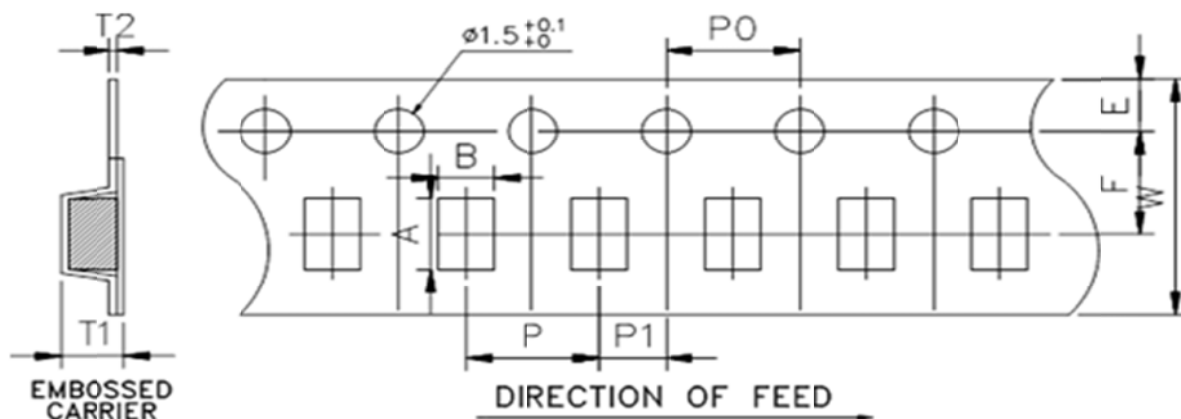

單位: mm

DIM Item	A	B	W	E	F	T1	T2	P	P0	10*P0	P1
LR1206 (0.3~0.6mΩ)	3.50±0.10	1.90±0.10	8.0±0.15	1.75±0.10	3.5±0.10	1.27±0.10	0.23±0.10	4.0±0.10	4.0±0.10	40.0±0.20	2.0±0.10
LR1206 (≥1.0mΩ)	3.48±0.10	1.83±0.10	8.0±0.15	1.75±0.10	3.5±0.10	1.10±0.10	0.20±0.05	4.0±0.10	4.0±0.10	40.0±0.20	2.0±0.10
LR2010	5.45±0.10	2.90±0.10	12.0±0.15	1.75±0.10	5.5±0.10	1.33±0.10	0.23±0.05	4.0±0.10	4.0±0.10	40.0±0.20	2.0±0.10
LR2512 (0.3mΩ)	6.74±0.10	3.50±0.10	12.0±0.15	1.75±0.10	5.5±0.10	1.60±0.10	0.24±0.05	8.0±0.10	4.0±0.10	40.0±0.20	2.0±0.10
LR2512	6.75±0.10	3.50±0.10	12.0±0.15	1.75±0.10	5.5±0.10	1.30±0.10	0.20±0.05	4.0±0.10	4.0±0.10	40.0±0.20	2.0±0.10
LR2725	7.15±0.10	6.75±0.10	12.0±0.15	1.75±0.10	5.5±0.10	1.95±0.10	0.25±0.05	8.0±0.10	4.0±0.10	40.0±0.20	2.0±0.10
LR2728	7.15±0.10	7.70±0.10	12.0±0.15	1.75±0.10	5.5±0.10	1.45±0.10	0.25±0.05	12.0±0.10	4.0±0.10	40.0±0.20	2.0±0.10
LR4527	11.80±0.10	7.20±0.10	24.0±0.15	1.75±0.10	11.5±0.10	2.00±0.10	0.30±0.10	12.0±0.10	4.0±0.10	40.0±0.20	2.0±0.10
LR4527S	11.80±0.10	7.20±0.10	24.0±0.15	1.75±0.10	11.5±0.10	2.00±0.10	0.30±0.10	12.0±0.10	4.0±0.10	40.0±0.20	2.0±0.10

備註

非發行管制文件
自行注意版本更新

非經允許，禁止自行影印文件

發行管制章 DATA Center.

Series No. 60

7.2 包裝型式(Packaging Model):

Type	Tape width	Max. Packaging Quantity (pcs/reel)		
		Embossed Plastic Type		
		4mm pitch	8mm pitch	12mm pitch
LR1206(0.3~0.6mΩ)	8mm	2,000pcs	--	--
LR1206(≥1.0mΩ)		4,000pcs		
LR2010	12mm	2,000pcs/4,000pcs	--	--
LR2512(0.3mΩ)		--	1,000pcs	--
LR2512		4,000pcs	--	--
LR2725		--	1,000pcs	--
LR2728		--	--	1,000pcs
LR4527 LR4527S	24mm	--	--	500pcs

7.3 塑膠圓盤尺寸(Reel Dimensions):

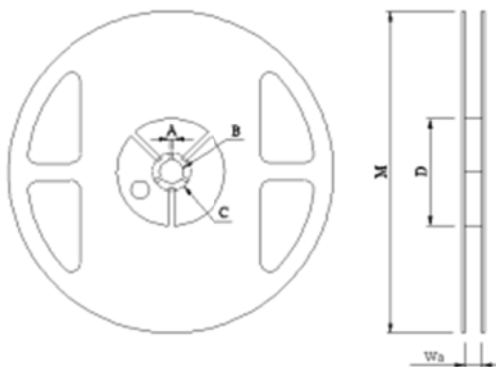

單位: mm

Reel Type / Tape	W	M	A	B	C	D
7" reel for 8 mm tape	9.0 ± 0.5	178 ± 2.0	2.0 ± 0.5	13.5 ± 0.5	21.0 ± 0.5	60.0 ± 1.0
7" reel for 12 mm tape	13.8 ± 0.5					80.0 ± 1.0
7" reel for 24 mm tape	25.0 ± 1.0			60.0 ± 1.0		

7.4 標籤表示(Label):

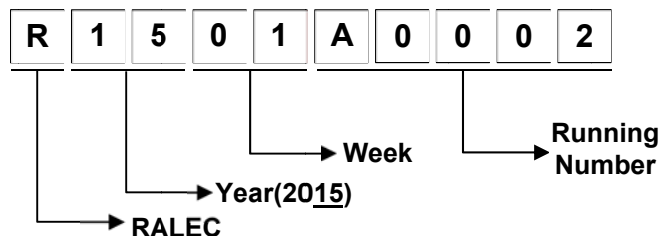

備註

非發行管制文件
自行注意版本更新

非經允許，禁止自行影印文件

發行管制章 DATA Center.

Series No. 60

7.5 內盒尺寸

Reel Number (for 8 mm tape)	Reel Number (for 12 mm tape)	Reel Number (for 24 mm tape)	D Dimension (mm)
1	-	-	12
2	1	-	24
3	2	1	36
4	-	-	48
5	3	2	60
6	4	-	72
7	-	3	84
8	-	-	96
9	-	-	108
10	-	4	120

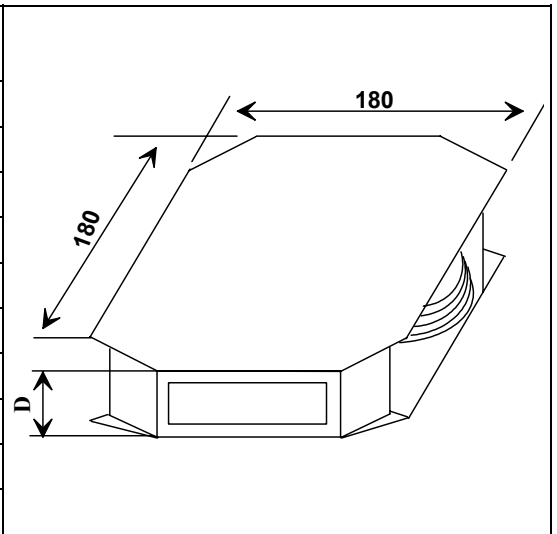

7.6 外箱尺寸

10R內盒個數	長(mm)	寬(mm)	厚(mm)
2	272	205	210
4	375	280	210
8	544	380	210

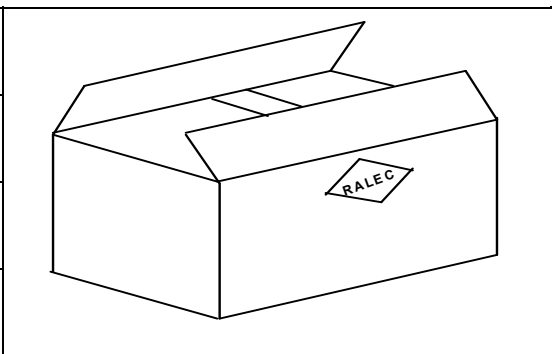

7.7 外銷中國大陸外箱尺寸:

10R內盒個數	長(mm)	寬(mm)	厚(mm)
2	272	205	210
4	375	280	210
8	544	380	210

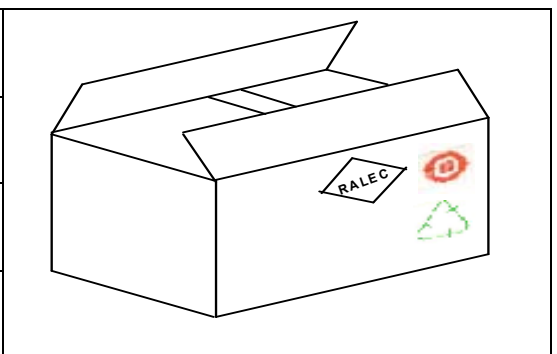

備註

非發行管制文件
自行注意版本更新

非經允許，禁止自行影印文件

發行管制章 DATA Center.

Series No. 60

8 技術資料(此為建議值，請客戶使用時依實際應用作調整)

8.1 建議焊錫條件：

表面黏著的零組件將在溫度245 °C/3秒下測試其焊錫性。以下為典型的焊接例子可提供可靠的焊接且不會造成任何損傷。

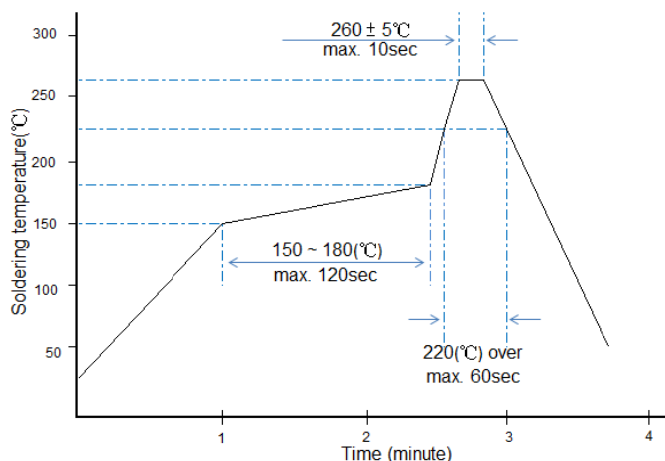

建議 IR Reflow Soldering Profile

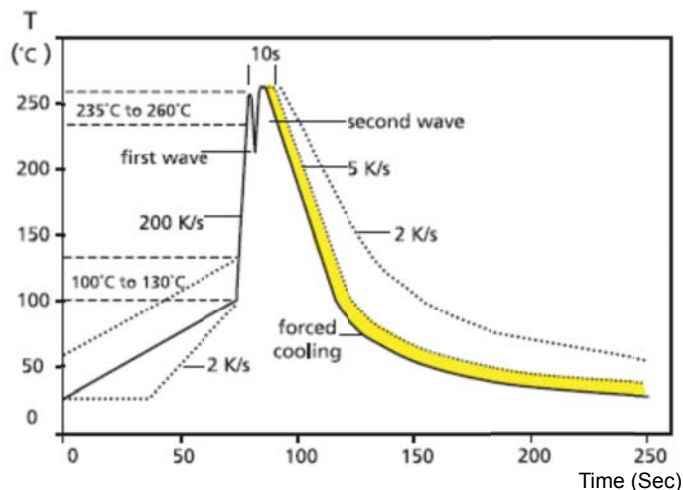

建議 double-wave Soldering Profile

實線：典型值

虛線：界限值

備

非發行管制文件
自行注意版本更新

發行管制章 DATA Center.

註

非經允許，禁止自行影印文件

Series No. 60

8.2 建議 Land Pattern:

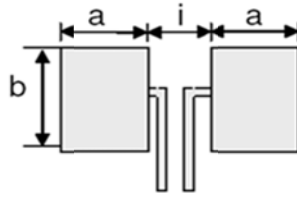

Type	Maximum Power Rating (Watts)	Resistance Range (mΩ)	Dimensions - in millimeters		
			a	b	i
LR1206	0.5 & 1.0 & 1.5	0.3~0.6	1.65	2.18	0.90
		1.0 ~ 50.0	1.60		1.00
LR2010	1.0 & 1.5 & 2.0	0.5 ~ 3.0	2.89	2.92	1.22
		3.1 ~ 100.0	2.29		2.41
LR2512	1.0 & 1.5	0.3 ~ 4.0	3.05	3.68	1.27
		4.1 ~ 100.0	2.11		3.18
	2.0	0.3 ~ 4.0	3.05		1.27
		4.1 ~ 75.0	2.11		3.18
	3.0	0.3~0.5	3.05		1.27
		0.6~2.9 & 4.1 ~ 10.0	2.19		3.00
3.0 ~ 4.0	2.79	1.80			
LR2725	4.0 & 5.0	0.20 ~ 3.0	3.18	6.86	1.32
LR2728	3.0 & 3.5 & 4.0	4.0 ~ 100.0	2.75	7.82	3.51
LR4527S	2.0	0.5 ~ 5.0	4.80	8.74	5.51
		5.1 ~ 100.0	3.40		8.31
	3.0	0.5 ~ 5.0	4.80		5.51
		5.1 ~ 27.0	3.40		8.31
	5.0	0.5 ~ 5.0	4.80		5.51
		5.1 ~ 7.5	3.40		8.31
LR4527	5.0	0.5 ~ 5.0	4.80	8.74	5.51
		5.1 ~ 200.0	3.40		8.31

備

非發行管制文件
自行注意版本更新

發行管制章 DATA Center.

註

非經允許，禁止自行影印文件

Series No. **60**

8.3 點膠方式建議

8.3.1 因製程關係，本公司產品結構會有兩側偏薄現象(如下圖示)

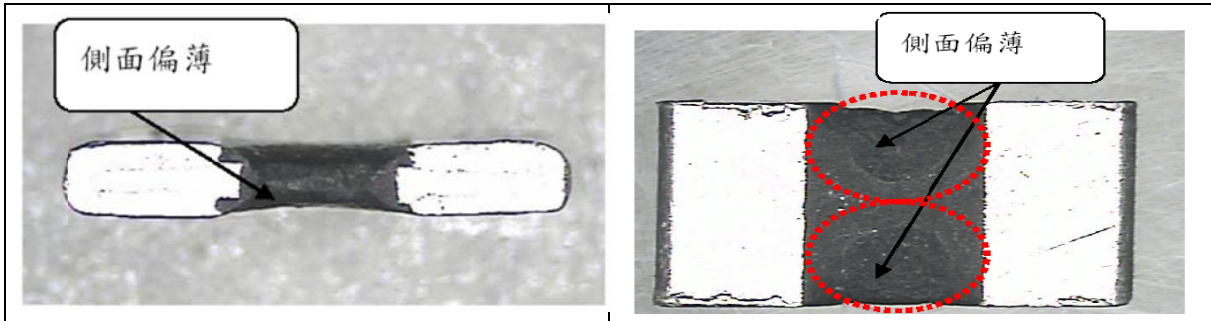

8.3.2 建議Wave Solder 製程客戶注意點膠之間距，如兩個紅膠間距過大，容易造成紅膠未黏住電阻本體，產生掉件(如圖一)問題，建議客戶點膠的間距適度縮小(如圖二)，或點於本體中央(如圖三)。

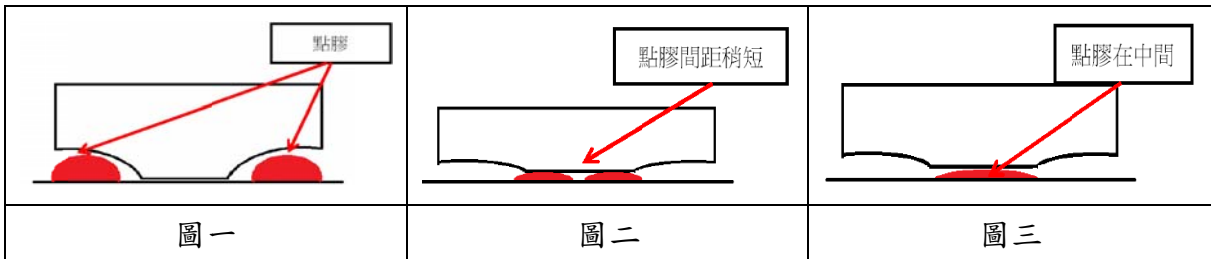

備

非發行管制文件
自行注意版本更新

發行管制章 DATA Center.

註

非經允許，禁止自行影印文件

Series No. 60

8.4 產品焊錫保證面

8.4.1 LR4527S(2W&5W) :

距邊緣0.5mm為可能沾錫區域，但不會影響信賴性

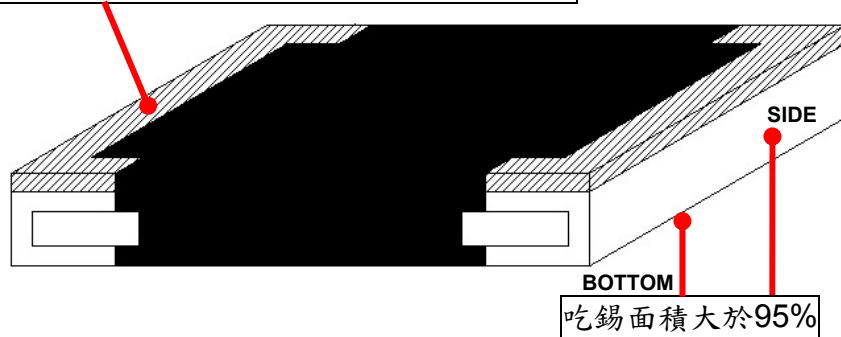

8.4.2 其他型別：

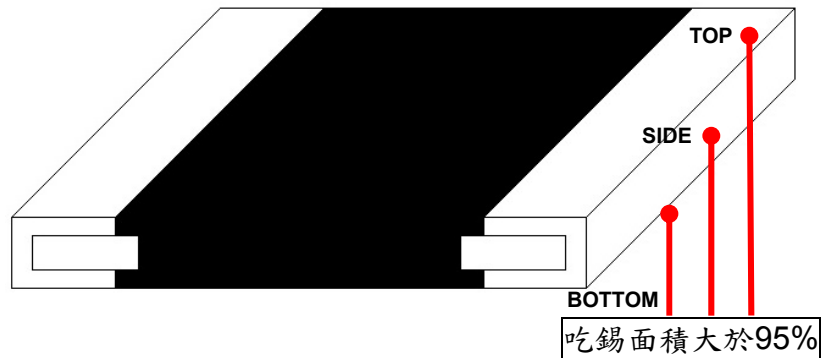

9 儲存期限：

9.1 在儲存環境 $25\pm 5^{\circ}\text{C}$ 、 $60\pm 15\%$ 之條件下可儲存二年。

10 附件

10.1 文件修訂記錄表 (QA-QR-027)

備

非發行管制文件
自行注意版本更新

發行管制章 DATA Center.

註

非經允許，禁止自行影印文件

Series No. 60