

MMBT3904LT1

Preferred Device

General Purpose Transistor NPN Silicon

Features

- Pb-Free Packages are Available

MAXIMUM RATINGS

Rating	Symbol	Value	Unit
Collector–Emitter Voltage	V_{CEO}	40	Vdc
Collector–Base Voltage	V_{CBO}	60	Vdc
Emitter–Base Voltage	V_{EBO}	6.0	Vdc
Collector Current – Continuous	I_C	200	mA _{dc}

THERMAL CHARACTERISTICS

Characteristic	Symbol	Max	Unit
Total Device Dissipation FR–5 Board (Note 1) $T_A = 25^\circ\text{C}$ Derate above 25°C	P_D	225 1.8	mW mW/ $^\circ\text{C}$
Thermal Resistance Junction to Ambient	$R_{\theta JA}$	556	$^\circ\text{C}/\text{W}$
Total Device Dissipation Alumina Substrate, (Note 2) $T_A = 25^\circ\text{C}$ Derate above 25°C	P_D	300 2.4	mW mW/ $^\circ\text{C}$
Thermal Resistance Junction–to–Ambient	$R_{\theta JA}$	417	$^\circ\text{C}/\text{W}$
Junction and Storage Temperature	T_J, T_{stg}	–55 to +150	$^\circ\text{C}$

- FR–5 = $1.0 \times 0.75 \times 0.062$ in.
- Alumina = $0.4 \times 0.3 \times 0.024$ in. 99.5% alumina.



ON Semiconductor®

<http://onsemi.com>

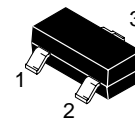
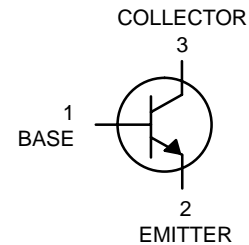

SOT–23 (TO–236)
CASE 318
Style 6

1AM = Specific Device Code

MARKING DIAGRAM

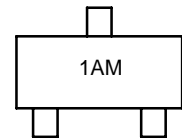

ORDERING INFORMATION

Device	Package	Shipping†
MMBT3904LT1	SOT–23	3000 / Tape & Reel
MMBT3904LT1G	SOT–23	3000 / Tape & Reel
MMBT3904LT3	SOT–23	10000 / Tape & Reel
MMBT3904LT3G	SOT–23	10000 / Tape & Reel

†For information on tape and reel specifications, including part orientation and tape sizes, please refer to our Tape and Reel Packaging Specifications Brochure, BRD8011/D.

Preferred devices are recommended choices for future use and best overall value.

MMBT3904LT1

ELECTRICAL CHARACTERISTICS ($T_A = 25^\circ\text{C}$ unless otherwise noted)

Characteristic	Symbol	Min	Max	Unit
OFF CHARACTERISTICS				
Collector-Emitter Breakdown Voltage ($I_C = 1.0\text{ mAdc}$, $I_B = 0$)	$V_{(BR)CEO}$	40	-	Vdc
Collector-Base Breakdown Voltage ($I_C = 10\text{ }\mu\text{Adc}$, $I_E = 0$)	$V_{(BR)CBO}$	60	-	Vdc
Emitter-Base Breakdown Voltage ($I_E = 10\text{ }\mu\text{Adc}$, $I_C = 0$)	$V_{(BR)EBO}$	6.0	-	Vdc
Base Cutoff Current ($V_{CE} = 30\text{ Vdc}$, $V_{EB} = 3.0\text{ Vdc}$)	I_{BL}	-	50	nAdc
Collector Cutoff Current ($V_{CE} = 30\text{ Vdc}$, $V_{EB} = 3.0\text{ Vdc}$)	I_{CEX}	-	50	nAdc

ON CHARACTERISTICS (Note 3)

DC Current Gain ($I_C = 0.1\text{ mAdc}$, $V_{CE} = 1.0\text{ Vdc}$) ($I_C = 1.0\text{ mAdc}$, $V_{CE} = 1.0\text{ Vdc}$) ($I_C = 10\text{ mAdc}$, $V_{CE} = 1.0\text{ Vdc}$) ($I_C = 50\text{ mAdc}$, $V_{CE} = 1.0\text{ Vdc}$) ($I_C = 100\text{ mAdc}$, $V_{CE} = 1.0\text{ Vdc}$)	H_{FE}	40 70 100 60 30	- - 300 - -	-
Collector-Emitter Saturation Voltage ($I_C = 10\text{ mAdc}$, $I_B = 1.0\text{ mAdc}$) ($I_C = 50\text{ mAdc}$, $I_B = 5.0\text{ mAdc}$)	$V_{CE(sat)}$	- -	0.2 0.3	Vdc
Base-Emitter Saturation Voltage ($I_C = 10\text{ mAdc}$, $I_B = 1.0\text{ mAdc}$) ($I_C = 50\text{ mAdc}$, $I_B = 5.0\text{ mAdc}$)	$V_{BE(sat)}$	0.65 -	0.85 0.95	Vdc

SMALL-SIGNAL CHARACTERISTICS

Current-Gain - Bandwidth Product ($I_C = 10\text{ mAdc}$, $V_{CE} = 20\text{ Vdc}$, $f = 100\text{ MHz}$)	f_T	300	-	MHz
Output Capacitance ($V_{CB} = 5.0\text{ Vdc}$, $I_E = 0$, $f = 1.0\text{ MHz}$)	C_{obo}	-	4.0	pF
Input Capacitance ($V_{EB} = 0.5\text{ Vdc}$, $I_C = 0$, $f = 1.0\text{ MHz}$)	C_{ibo}	-	8.0	pF
Input Impedance ($V_{CE} = 10\text{ Vdc}$, $I_C = 1.0\text{ mAdc}$, $f = 1.0\text{ kHz}$)	h_{ie}	1.0	10	k ohms
Voltage Feedback Ratio ($V_{CE} = 10\text{ Vdc}$, $I_C = 1.0\text{ mAdc}$, $f = 1.0\text{ kHz}$)	h_{re}	0.5	8.0	$\times 10^{-4}$
Small-Signal Current Gain ($V_{CE} = 10\text{ Vdc}$, $I_C = 1.0\text{ mAdc}$, $f = 1.0\text{ kHz}$)	h_{fe}	100	400	-
Output Admittance ($V_{CE} = 10\text{ Vdc}$, $I_C = 1.0\text{ mAdc}$, $f = 1.0\text{ kHz}$)	h_{oe}	1.0	40	μmhos
Noise Figure ($V_{CE} = 5.0\text{ Vdc}$, $I_C = 100\text{ }\mu\text{Adc}$, $R_S = 1.0\text{ k ohms}$, $f = 1.0\text{ kHz}$)	NF	-	5.0	dB

SWITCHING CHARACTERISTICS

Delay Time	$(V_{CC} = 3.0\text{ Vdc}$, $V_{BE} = -0.5\text{ Vdc}$, $I_C = 10\text{ mAdc}$, $I_{B1} = 1.0\text{ mAdc}$)	t_d	-	35	ns
Rise Time		t_r	-	35	
Storage Time	$(V_{CC} = 3.0\text{ Vdc}$, $I_C = 10\text{ mAdc}$, $I_{B1} = I_{B2} = 1.0\text{ mAdc}$)	t_s	-	200	ns
Fall Time		t_f	-	50	

3. Pulse Test: Pulse Width $\leq 300\text{ }\mu\text{s}$, Duty Cycle $\leq 2.0\%$.

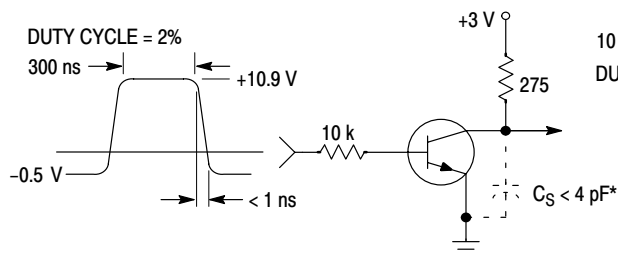

Figure 1. Delay and Rise Time Equivalent Test Circuit

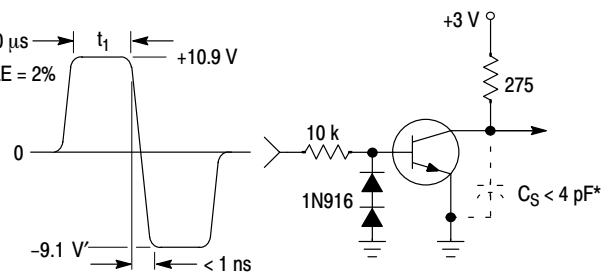

Figure 2. Storage and Fall Time Equivalent Test Circuit

* Total shunt capacitance of test jig and connectors

MMBT3904LT1

TYPICAL TRANSIENT CHARACTERISTICS

— $T_J = 25^\circ\text{C}$
 - - - $T_J = 125^\circ\text{C}$

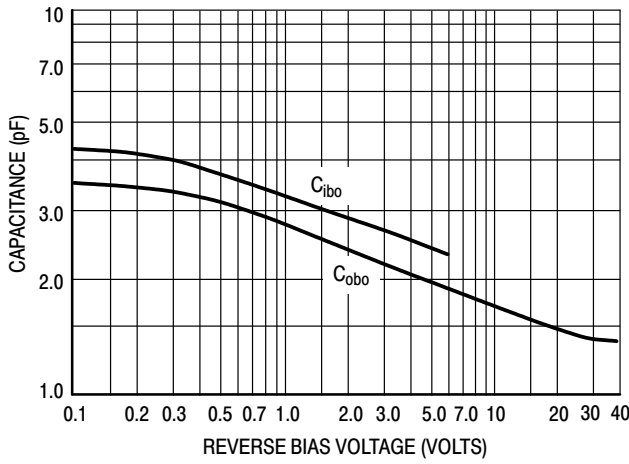

Figure 3. Capacitance

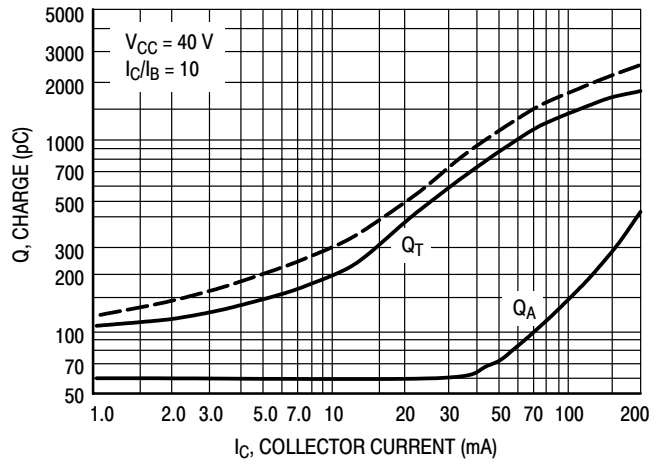

Figure 4. Charge Data

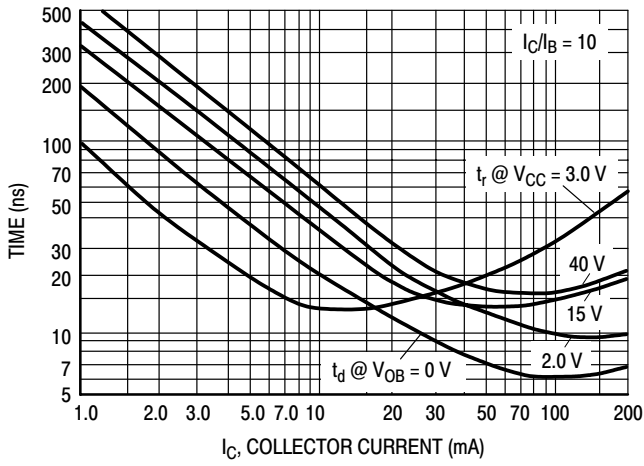

Figure 5. Turn-On Time

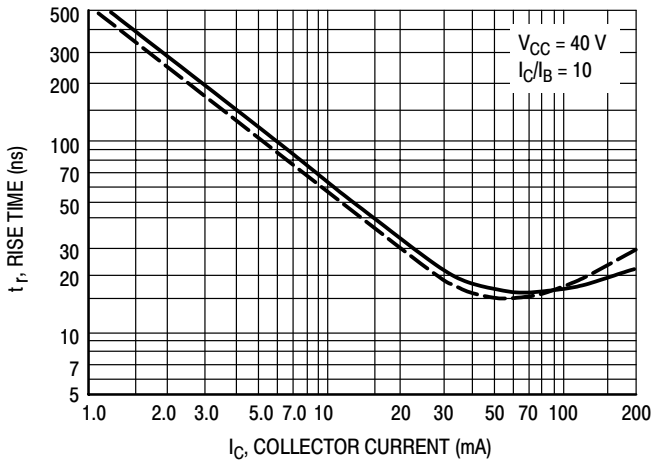

Figure 6. Rise Time

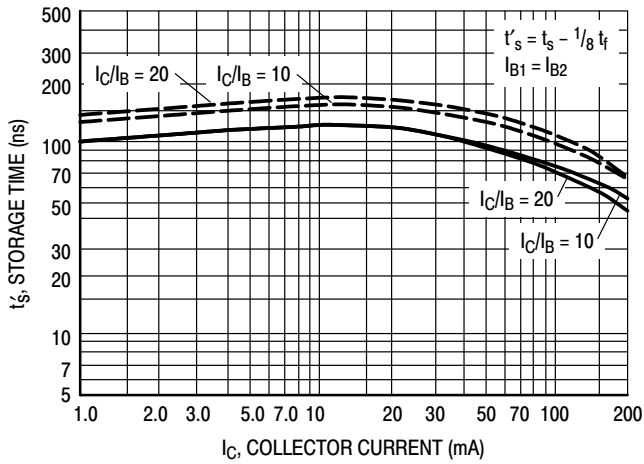

Figure 7. Storage Time

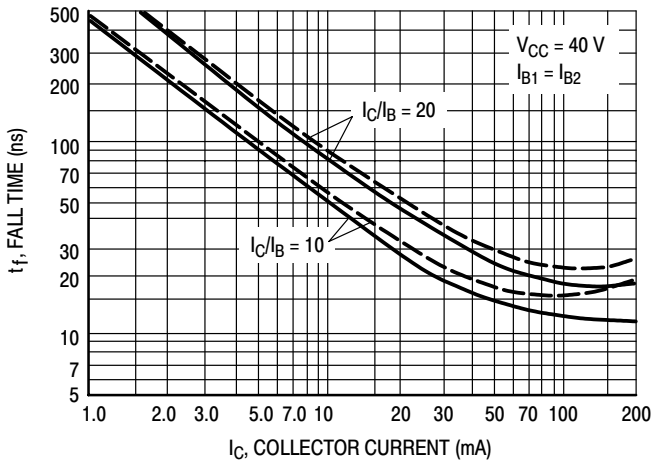

Figure 8. Fall Time

MMBT3904LT1

TYPICAL AUDIO SMALL-SIGNAL CHARACTERISTICS NOISE FIGURE VARIATIONS

($V_{CE} = 5.0$ Vdc, $T_A = 25^\circ\text{C}$, Bandwidth = 1.0 Hz)

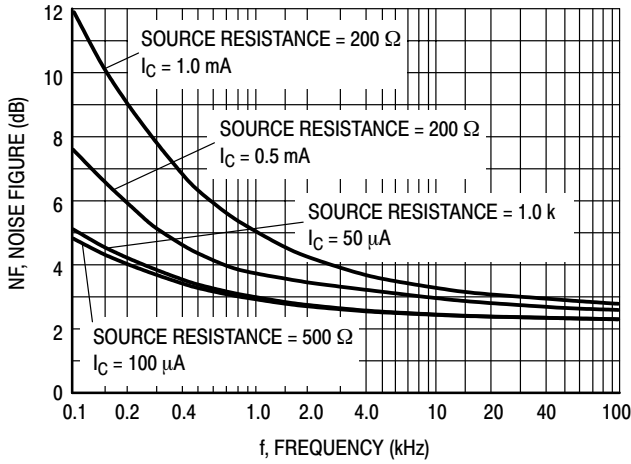

Figure 9.

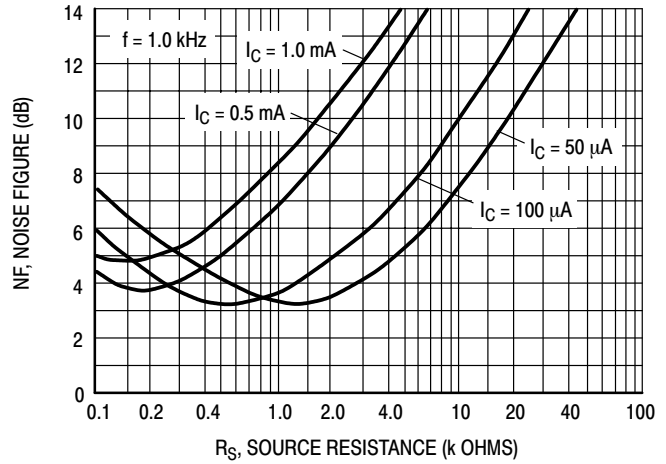

Figure 10.

h PARAMETERS

($V_{CE} = 10$ Vdc, $f = 1.0$ kHz, $T_A = 25^\circ\text{C}$)

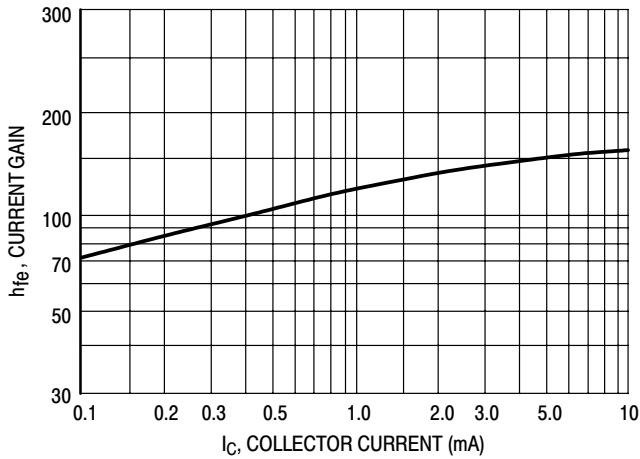

Figure 11. Current Gain

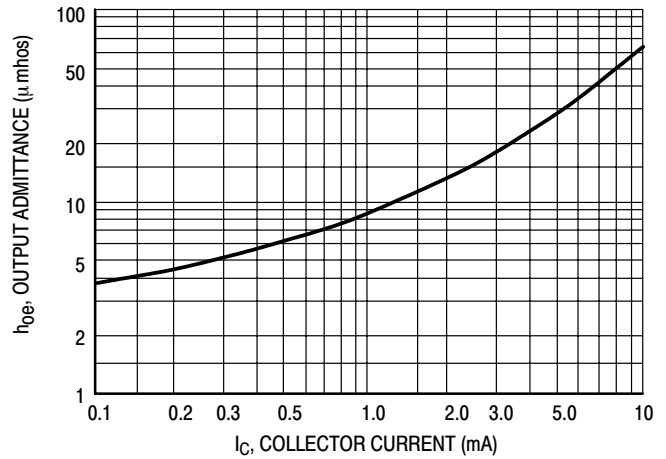

Figure 12. Output Admittance

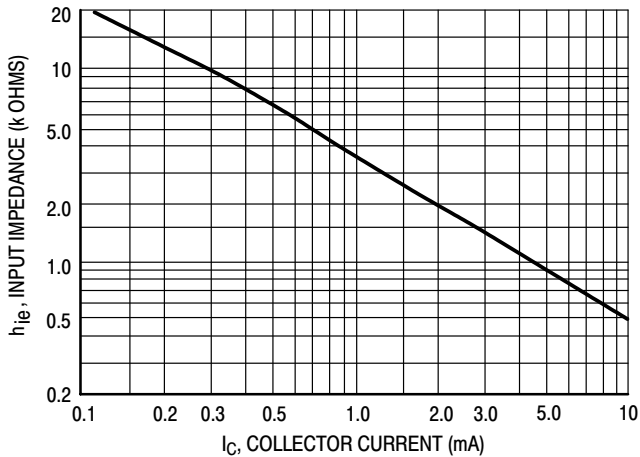

Figure 13. Input Impedance

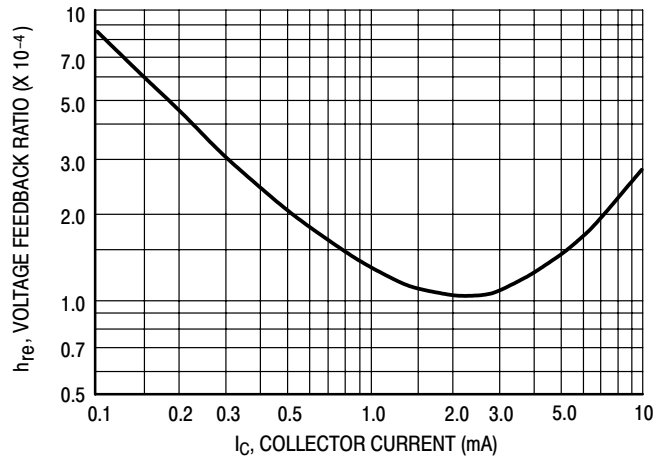

Figure 14. Voltage Feedback Ratio

MMBT3904LT1

TYPICAL STATIC CHARACTERISTICS

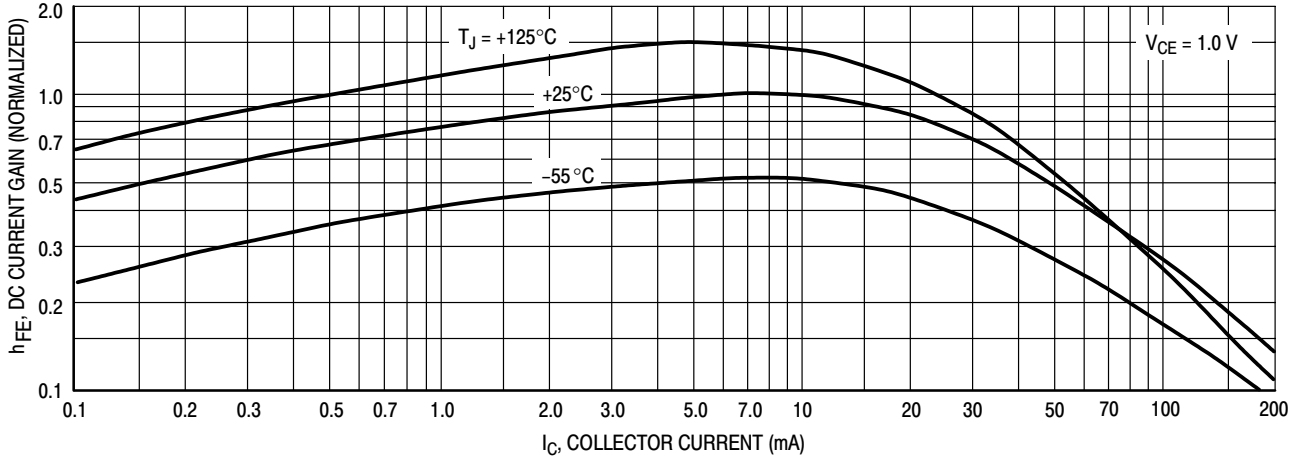

Figure 15. DC Current Gain

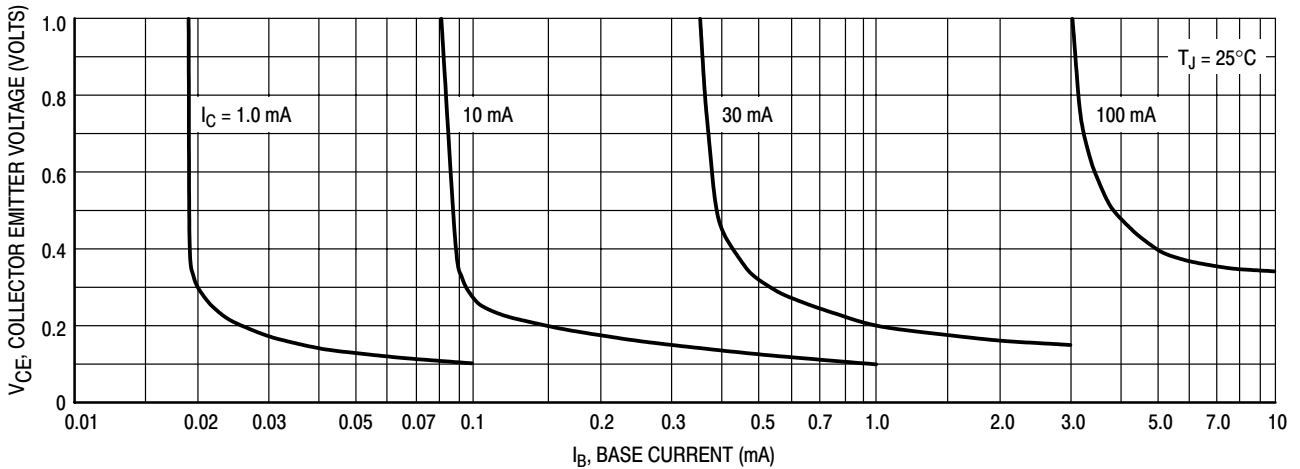

Figure 16. Collector Saturation Region

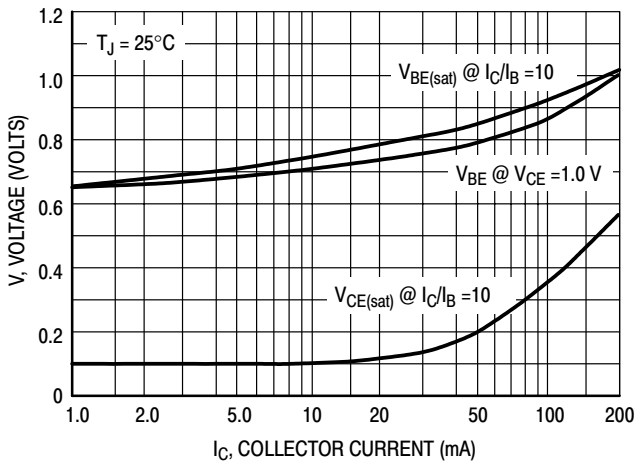

Figure 17. "ON" Voltages

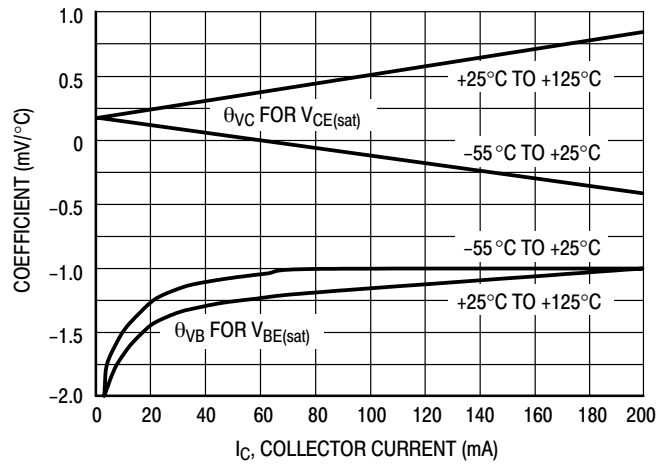

Figure 18. Temperature Coefficients

MMBT3904LT1

PACKAGE DIMENSIONS

SOT-23 (TO-236)
CASE 318-08
ISSUE AH

NOTES:

1. DIMENSIONING AND TOLERANCING PER ANSI Y14.5M, 1982.
2. CONTROLLING DIMENSION: INCH.
3. MAXIMUM LEAD THICKNESS INCLUDES LEAD FINISH THICKNESS. MINIMUM LEAD THICKNESS IS THE MINIMUM THICKNESS OF BASE MATERIAL.
4. 318-03 AND -07 OBSOLETE, NEW STANDARD 318-08.

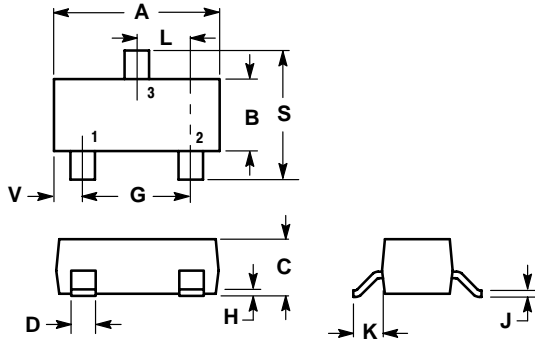

DIM	INCHES		MILLIMETERS	
	MIN	MAX	MIN	MAX
A	0.1102	0.1197	2.80	3.04
B	0.0472	0.0551	1.20	1.40
C	0.0350	0.0440	0.89	1.11
D	0.0150	0.0200	0.37	0.50
G	0.0701	0.0807	1.78	2.04
H	0.0005	0.0040	0.013	0.100
J	0.0034	0.0070	0.085	0.177
K	0.0140	0.0285	0.35	0.69
L	0.0350	0.0401	0.89	1.02
S	0.0830	0.1039	2.10	2.64
V	0.0177	0.0236	0.45	0.60

STYLE 6:

- PIN 1. BASE
- EMITTER
- COLLECTOR

SOLDERING FOOTPRINT*

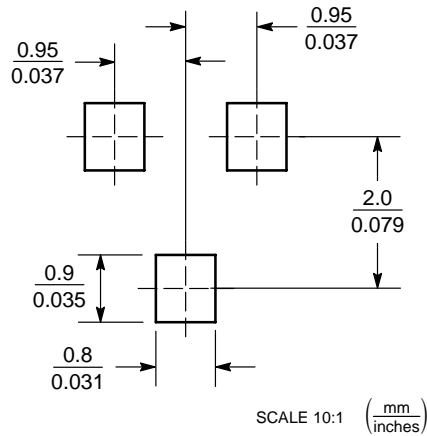

Figure 19. SOT-23

*For additional information on our Pb-Free strategy and soldering details, please download the ON Semiconductor Soldering and Mounting Techniques Reference Manual, SOLDERRM/D.

ON Semiconductor and are registered trademarks of Semiconductor Components Industries, LLC (SCILLC). SCILLC reserves the right to make changes without further notice to any products herein. SCILLC makes no warranty, representation or guarantee regarding the suitability of its products for any particular purpose, nor does SCILLC assume any liability arising out of the application or use of any product or circuit, and specifically disclaims any and all liability, including without limitation special, consequential or incidental damages. "Typical" parameters which may be provided in SCILLC data sheets and/or specifications can and do vary in different applications and actual performance may vary over time. All operating parameters, including "Typicals" must be validated for each customer application by customer's technical experts. SCILLC does not convey any license under its patent rights nor the rights of others. SCILLC products are not designed, intended, or authorized for use as components in systems intended for surgical implant into the body, or other applications intended to support or sustain life, or for any other application in which the failure of the SCILLC product could create a situation where personal injury or death may occur. Should Buyer purchase or use SCILLC products for any such unintended or unauthorized application, Buyer shall indemnify and hold SCILLC and its officers, employees, subsidiaries, affiliates, and distributors harmless against all claims, costs, damages, and expenses, and reasonable attorney fees arising out of, directly or indirectly, any claim of personal injury or death associated with such unintended or unauthorized use, even if such claim alleges that SCILLC was negligent regarding the design or manufacture of the part. SCILLC is an Equal Opportunity/Affirmative Action Employer. This literature is subject to all applicable copyright laws and is not for resale in any manner.

PUBLICATION ORDERING INFORMATION

LITERATURE FULFILLMENT:
Literature Distribution Center for ON Semiconductor
P.O. Box 5163, Denver, Colorado 80217 USA
Phone: 303-675-2175 or 800-344-3860 Toll Free USA/Canada
Fax: 303-675-2176 or 800-344-3867 Toll Free USA/Canada
Email: orderlit@onsemi.com

N. American Technical Support: 800-282-9855 Toll Free
USA/Canada

Japan: ON Semiconductor, Japan Customer Focus Center
2-9-1 Kamimeguro, Meguro-ku, Tokyo, Japan 153-0051
Phone: 81-3-5773-3850

ON Semiconductor Website: <http://onsemi.com>

Order Literature: <http://www.onsemi.com/litorder>

For additional information, please contact your local Sales Representative.

This datasheet has been downloaded from:

www.DatasheetCatalog.com

Datasheets for electronic components.